

T-GRID

Flexible Lighting Solutions
Universal Compatibility



US PATENT
10125934



We Believe in Simplicity = Beauty

Under a suspended ceiling construction, imagine a simple grid lighting system can save labor cost and reduce the building waste, but also show the characteristics of your commercial space. Let the ceiling tile shine with integrated lighting, we made it easy for you to specify and maintain the crisp. TB series is compatible with known industry's standard size ceiling tiles, whether it's 9/16" or 15/16".



Speed

It can be parallel connected up to 3pcs fixtures per power supply.



Flexibility

It is free to create compelling spaces, your space no longer has to be restricted to a single pattern on the ceiling.



Reduced Cost

Simply wiring and RJ45 terminal make easy installation and safe wiring.



Simplicity

0.48" thickness, almost integrated to T-grid ceiling.

Almost Integrated To The T-grid Ceiling
Slim Profile 0.48" Thickness

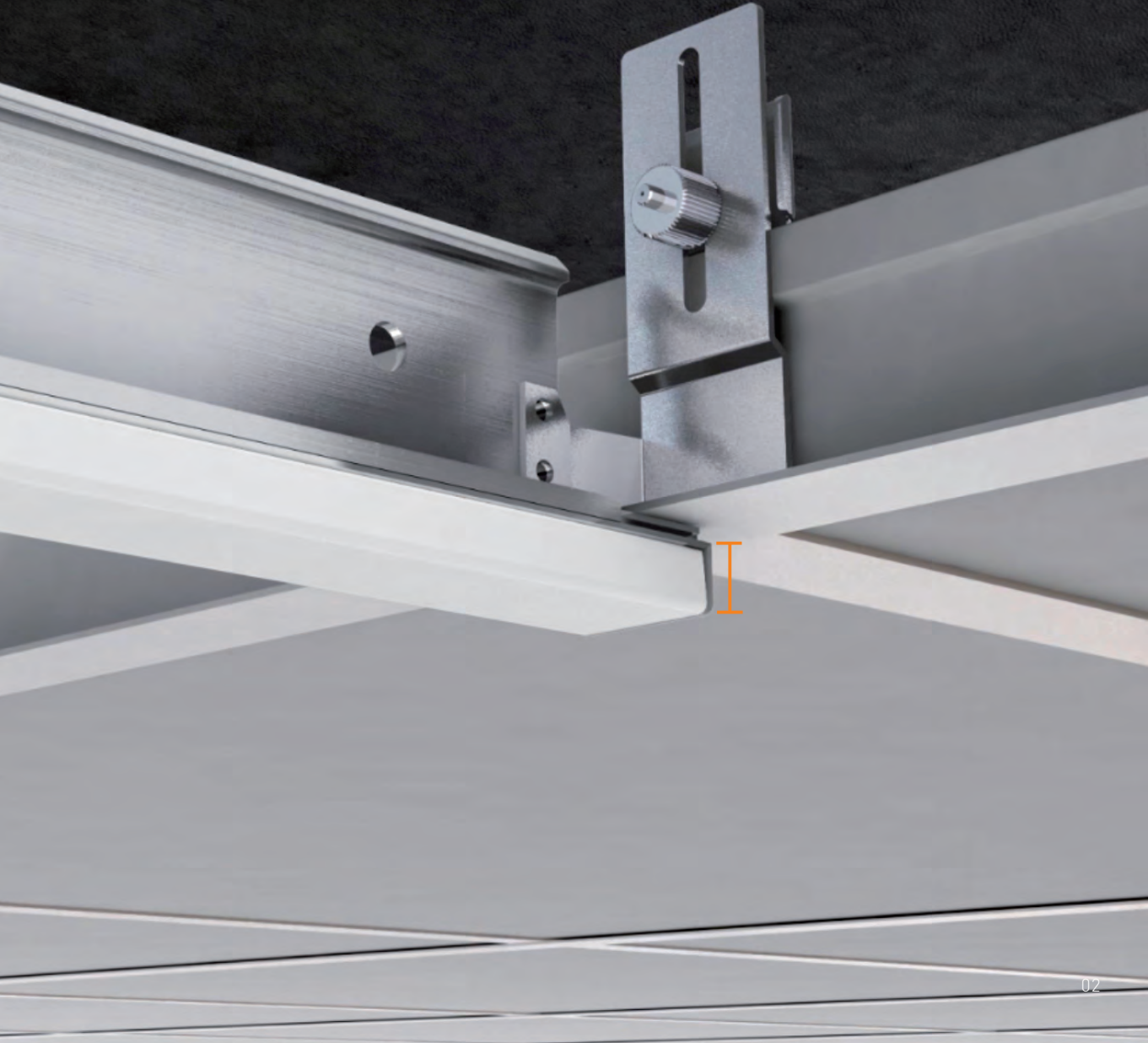

Versatility Meets Simplicity

Truly Universal Compatibility

It is a new generation green lighting solution that integrated into T-Grid suspended ceilings, allowing to be fully and seamlessly integrated into 9/16" flat, 9/16" slot, 9/16" interlude or 15/16" flat T-grid. It can replace selected cross tees of the suspended grid ceiling system where light is desired.

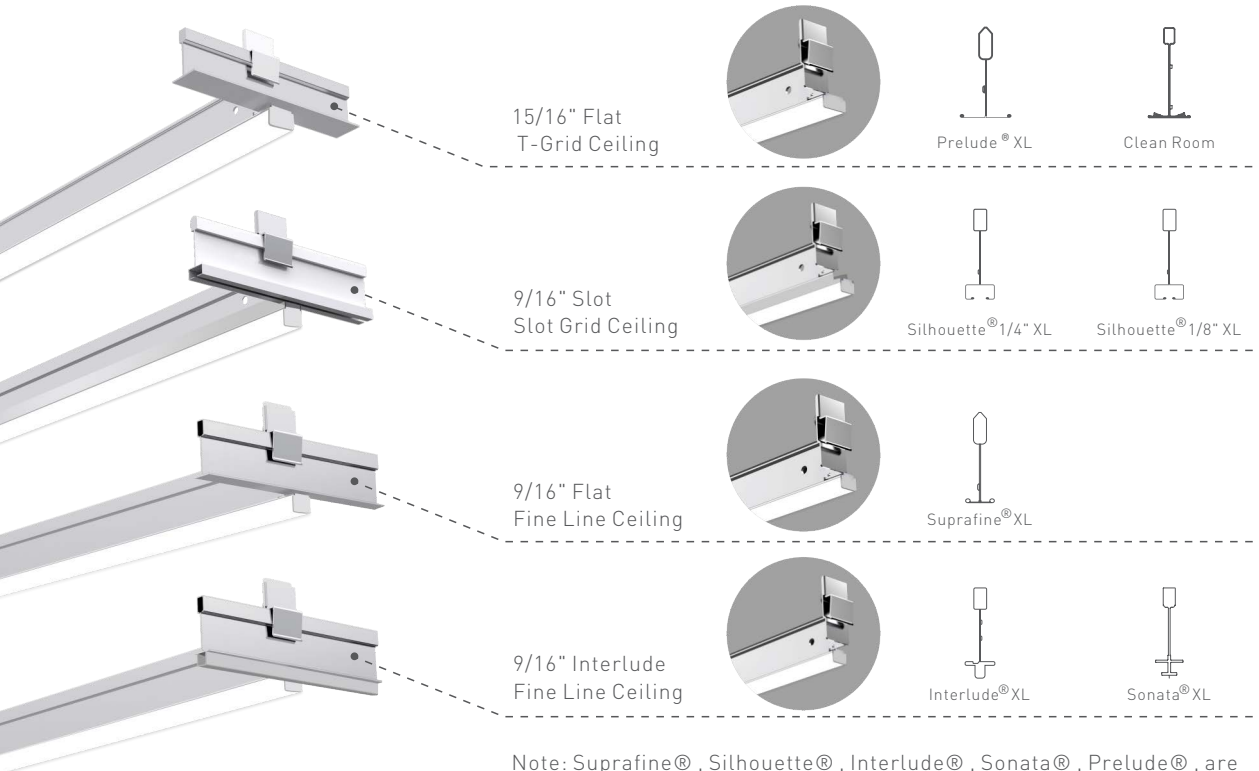

Note: Suprafine®, Silhouette®, Interlude®, Sonata®, Prelude®, are trademarks of Armstrong World Industries (AWI) company.

Lens Challenge

4 Different Precise Optics

The TB series is certain to meet the most stringent of application requirements. This innovative produce design brings both performance and aesthetics to any design applications.

Milky Diffuser

9/16" Flat, 9/16" Interlude,
9/16" Slot and 15/16" Flat
120° Beam Angle

T-Grid LED with diffusing cover has an added unique design with triple sides, to allow the light to diffuse for a direct and indirect lighting combination with 120° beam angle, and create a particular architectural statement while distributing the lumens over the entire space.

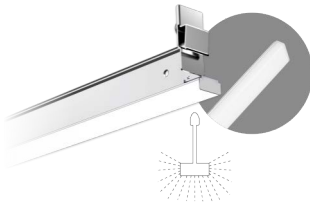

Micro Reflector

15/16"
85° Beam Angle

T-Grid LED with reflector is a great choice for applications where a concentrated angle of light is desired on task areas or table top surfaces with 85° beam angle.

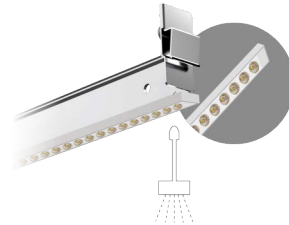

Clear Lens

15/16"
70° or 90° Beam Angle

T-Grid LED with diffusing lens for direct lighting is equipped with with controlled light distributions of beam angle options 70° and 90° for controlled distribution.

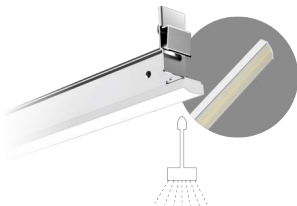

Signage

9/16"
110° Beam Angle

This is a perfect minimalistic solution for providing a flexible led sign with big beam angle, achieving indication and illumination function for commercial and institutional environments.

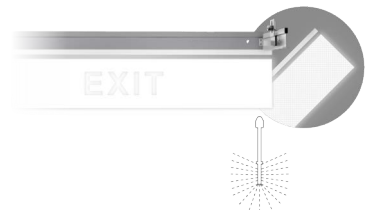

Lower Your Stock Risk

Replace The LED Module Randomly

The innovative separable design of led module and T-Grid bracket makes it more flexible. One T-grid bracket allows for seamless integration of multiple led modules with different CCT or types with easy and tool-free installation.



Ease Replaceable

Built on the core of its modern, practical design philosophy, the TB series allow easy access to repair or replacement of different CCT or lens becomes necessary.

- ① Remove the existing LED module



- ② Put in new LED module with different color temperatures or lens.



- ③ It's done in seconds



Flexible Lighting Solutions No Application Is Out of Reach

T-Grid LED can be installed in many configurations by replacing any of the cross tees between the main runners of the suspended grid ceiling system assembly, providing a flexible general lighting solution for commercial and institutional environments such as offices, classrooms, retail and public space.

Custom Pattern Version



Shape: L	
Qty	Parts
1	2' Linear Light
1	4' Linear Light



Shape: T	
Qty	Parts
2	2' Linear Light
1	4' Linear Light

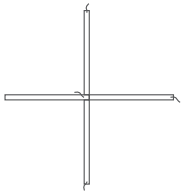

Shape: +	
Qty	Parts
4	2' Linear Light

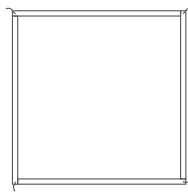

Shape: □	
Qty	Parts
4	4' Linear Light

Custom Configuration

Considering different dimension and functions of a room, it is free to create compelling spaces, and your space no longer has to be restricted to a single pattern on the ceiling.

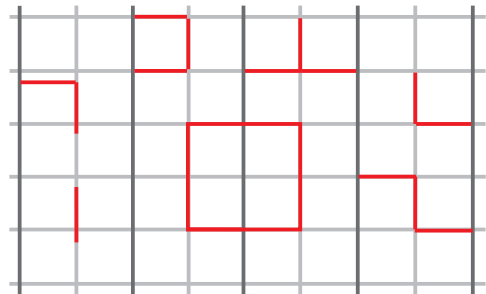

- Examples of configurations
- Possible positions for T-grid LED light modules
- One-piece main runner cannot be replaced



No Gap, Create Linear Lighting Atmosphere
Seamless Continuous Runs



Easy Wiring And Mess Free Save Cost Without Compromising Style

Brilliant design and intuitive engineering fearlessly combine to deliver unprecedented performance. TB series' striking contrast of effortless style and urban edginess makes a distinct statement in any suspending ceiling space. It can be parallel connected up to 6ft (2' fixture) and 12ft (4' fixture) max per power supply. Max distance from fixtures to power supply is 8 feet with 24 AWG cable. RJ45 terminal make easy installation and safe wiring.

Remote LED Driver

It can be parallel connected up to 6ft (2' fixture) and 12ft (4' fixture) max per power supply. Max distance from fixtures to power supply is 8 feet with 24 AWG cable. RJ45 terminal make easy installation and safe wiring.

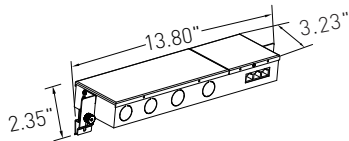

Optional Functions:

- 24V DC Options
- Emergency Option
- CCEA Option
- Custom Cable Length
- Plenum Rated Cable Option

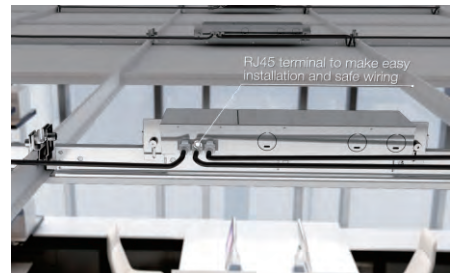
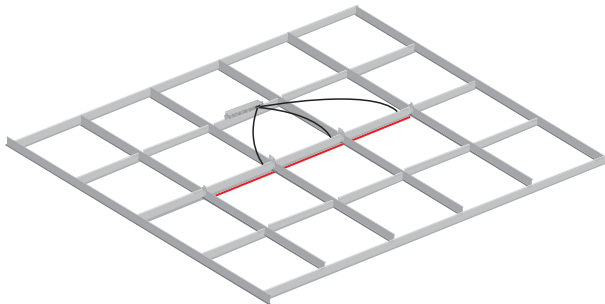

IC Rated

OKT's T-grid LED is IC rated, which has additional insulation materials either by code or design requirement for installation in suspended ceilings.





American's architectural and commercial LED Lighting Enthusiast

Founded in 2008, OKT is known for quality commercial and architectural lighting in North America. We deliver better light you can see, experience and benefit from. At OKT Lighting, our teams are made up of dreamers and doers who are committed to making better lighting. We're not only focused on making solutions that last, but on redefining what's possible, from the lighting we engineer to the value we add.

WE ARE YOUR RELIABLE PARTNER

We are your logistics hub. Our network covers entire North America.

- Shipping within 48 hours
- Without Stock Risk
- No Tariff Worries
- Live Inventory Access
- 24/7 Online Service
- Local Assembly*
- Prompt RMA
- Local OEM
- Dropship

We are your marketing dept., visual marketing support is available.

- Data Sheet
- Sales Sheet
- Installation Sheet
- IES
- Revit Files
- HD Photos
- Video
- Sample Bags
- Professional Product Training