

⚠ RISK OF FIRE AND ELECTRICAL SHOCK. FIXTURE MUST BE INSTALLED BY A QUALIFIED ELECTRICIAN ONLY IN ACCORDANCE WITH NATIONAL, LOCAL BUILDING AND ELECTRICAL CODES. DISCONNECT POWER AT ELECTRICAL PANEL BEFORE SERVICING.

IMPORTANT

1. Read all instructions.
2. Install in accordance with national and local electrical code regulations.
3. This product is intended to be installed and serviced by a qualified, licensed electrician.
4. Do not install in wet locations. For dry and damp use only.
5. Turn off electrical power before installing or servicing fixture in any way.
6. To reduce the risk of fire and overheating, make sure all connections are tight.
7. Under no circumstances can the lighting fixture be covered with heat insulation gasket or similar materials.
8. The maximum connection of each input line is 40FT(1200CM) in 120AC, 80FT(2400CM) in 230AC, 100FT(3000CM) in 277AC.

ACCESSORY

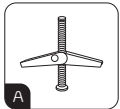

A Butterfly Drywall Anchor

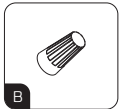

B Wire Nut

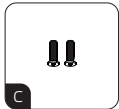

C Screw

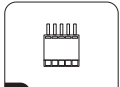

E Male quick connector (5 holes)



G Anchor



I Screw

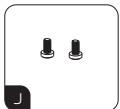

J Screw

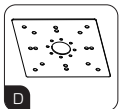

D Square plate (Optional accessory)

Noted: Square plate compatible for 4" octagon, 4" round, 4" square and 2x4" rectangle junction boxes.

WIRING

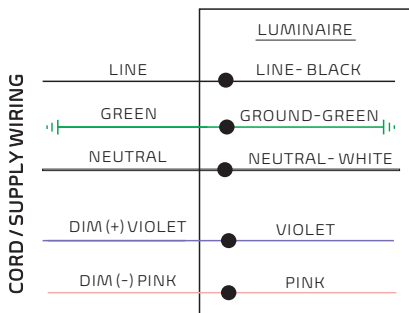

⚠ Please isolate two dimming wires by P2 terminal individually if no need dimming; **MUST connect wires with corresponding colors as shown.**

PRE-INSTALLATION

Assemble Power Cord

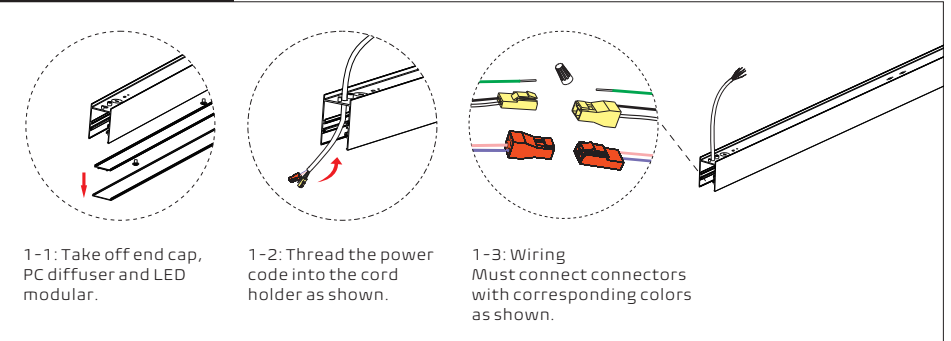

INDEPENDENT INSTALLATION

1 Prepare mounting point in the ceiling

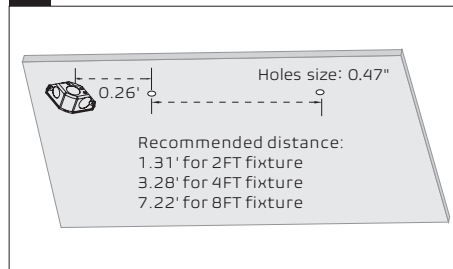

2 Mount plate and wiring

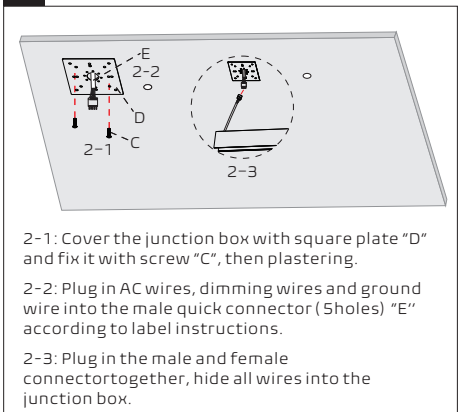

3 Screw the housing in the ceiling

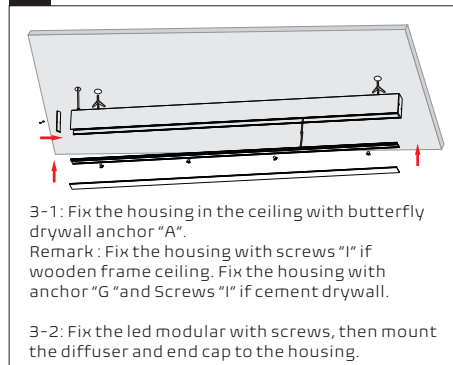

4 Complete

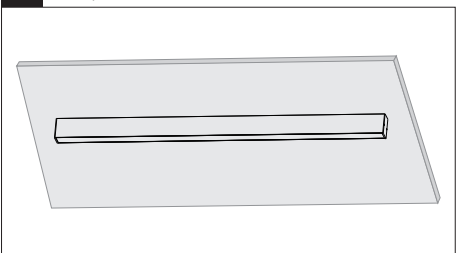

⚠ RISK OF FIRE AND ELECTRICAL SHOCK. FIXTURE MUST BE INSTALLED BY A QUALIFIED ELECTRICIAN ONLY IN ACCORDANCE WITH NATIONAL, LOCAL BUILDING AND ELECTRICAL CODES. DISCONNECT POWER AT ELECTRICAL PANEL BEFORE SERVICING.

JOINER OPTIONS



"—" Joiner



"L" Joiner



"V" Joiner



"T" Joiner



"+" Joiner



"Y" Joiner

Noted: It needs 2 inputs if using joiner "T", "+" and "Y".

ACCESSORY



Silicone Seal

Noted: Silicone Seal is used to seal seams that may appear at both ends of luminaires when multiple connections.

BEFORE CONNECTING

Disassemble Luminaires

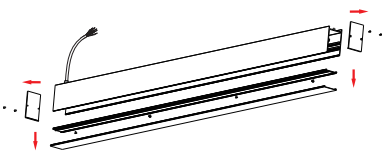

Start of run (SoR):

Take off both end caps and PC diffuser, assemble the power cord according to page 1.

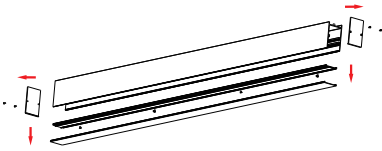

Middle of run (MoR):

Take off both end caps and PC diffuser

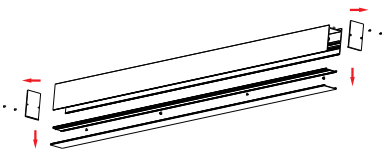

End of run (EoR):

Take off both end caps and PC diffuser

LINE CONNECTION

1 Prepare mounting point in the ceiling

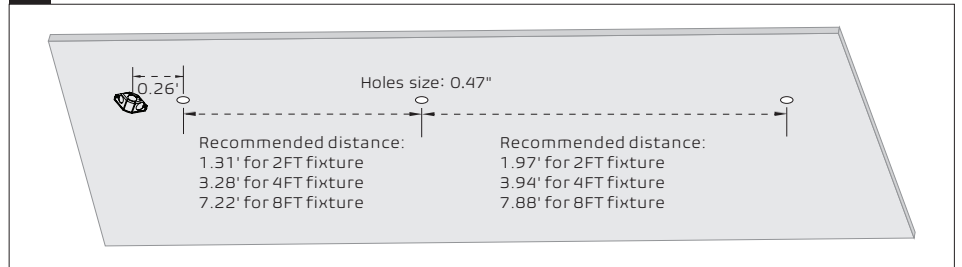

2 Mount plate and wiring

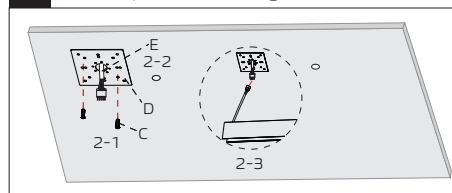

2-1: Cover the junction box with square plate "D" and fix it with screw "C", then plastering.

2-2: Plug in AC wires, dimming wires and ground wire into the male quick connector (5holes) "E" according to label instructions.

2-3: Plug in the male and female connector together, hide all wires into the junction box.

3 Install the housing and joiner – SoR

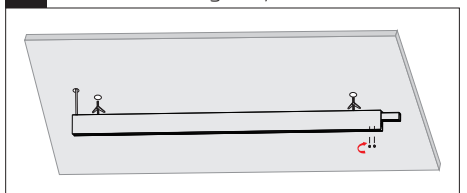

3-1: Fix the housing in the ceiling with butterfly drywall anchor "A".

Remark: Fix the housing with screws "I" if wooden frame ceiling. Fix the housing with anchor "G" and Screws "I" if cement drywall.

3-2: Insert the joiner "—" into the SoR housing and fix it by screws.

4 Repeat install and join steps-MoR to EoR

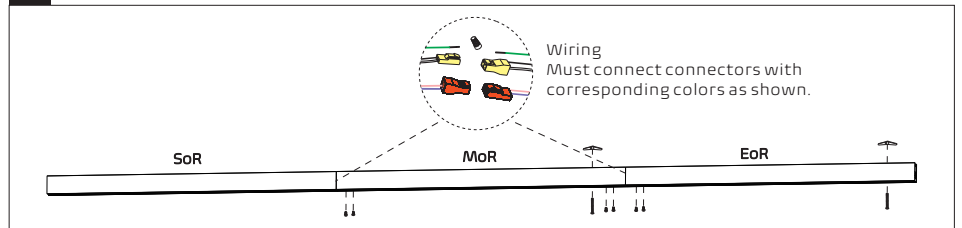

4-1: Fix the housing in the ceiling in turn.

4-2: Insert the joiner "—" into the housing and fix it by screws in turn.

4-3: Connect the quick connectors properly.

5 Reload LED modulators, diffusers and end caps

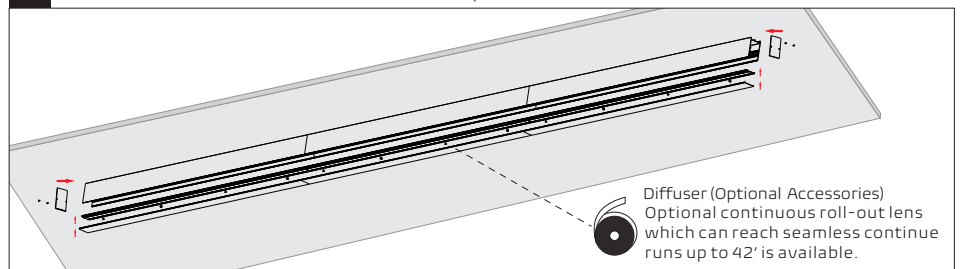

6 Complete

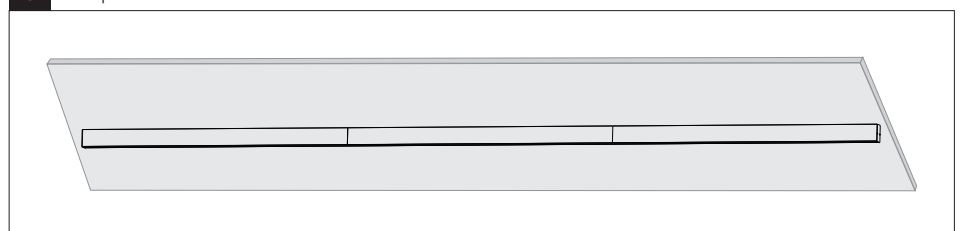

⚠ RISK OF FIRE AND ELECTRICAL SHOCK. FIXTURE MUST BE INSTALLED BY A QUALIFIED ELECTRICIAN ONLY IN ACCORDANCE WITH NATIONAL, LOCAL BUILDING AND ELECTRICAL CODES. DISCONNECT POWER AT ELECTRICAL PANEL BEFORE SERVICING.

L SHAPE CONNECTION

- ▲ For "T", "+", "Y" shape or other geometric shapes, all subject to the "L" shape installation.
- ▲ It needs 2 inputs if using joiner "T", "+" and "Y".

1 Make hole in the ceiling

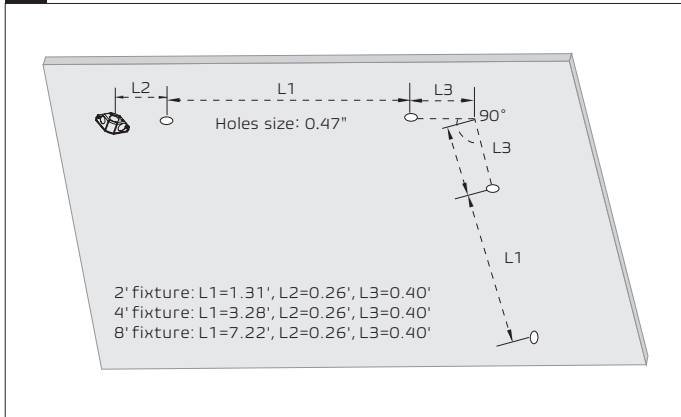

2 Mount plate and wiring

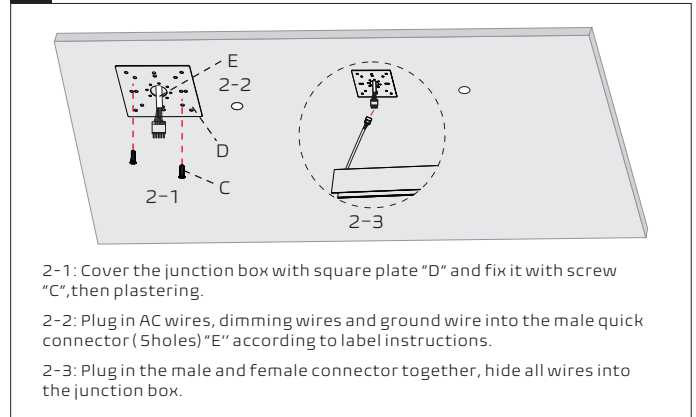

3 Install the housing and joiner – SoR

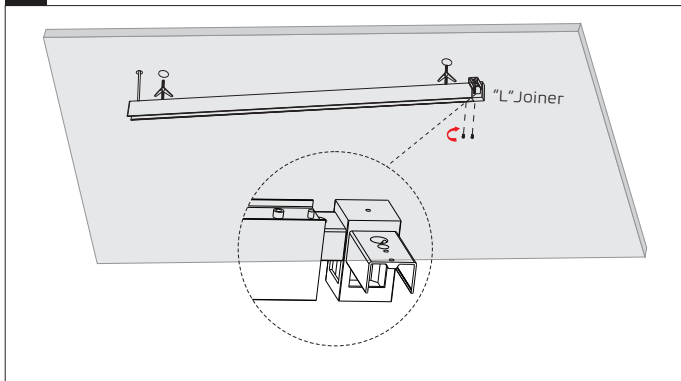

- 3-2: Insert the joiner "L" into the SoR housing and fix it by screws.

4 Repeat install and join steps-MoR to EoR

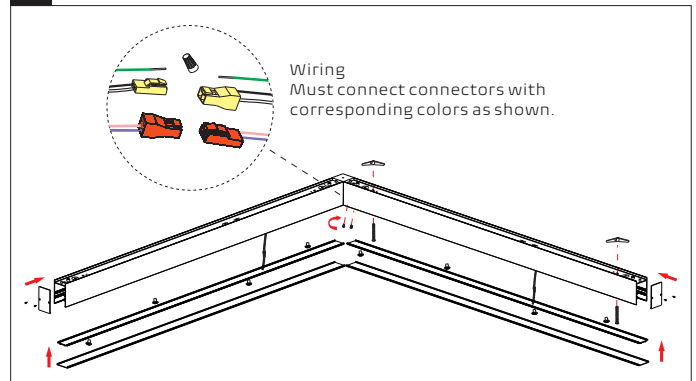

- 4-1: Fix the housing in the ceiling in turn.
- 4-2: Insert the joiner "L" into the housing and fix it by screws in turn.
- 4-3: Connect the quick connectors properly.
- 4-4: Reload the LED modulators and PC diffusers into the housing and fix the end caps with screws.

5 Complete

